

# SAVK

*Karanlıktan Savk'a*

2025  
FIYAT LİSTESİ



## İÇİNDEKİLER

Armatürler

1-18



Lambalar

19-27



Bantlar

28-29



Şerit Ledler

30-36

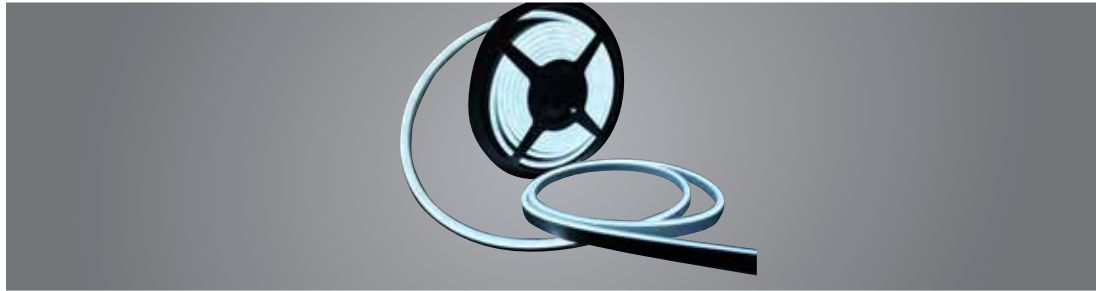

Özel Lambalar

37-41

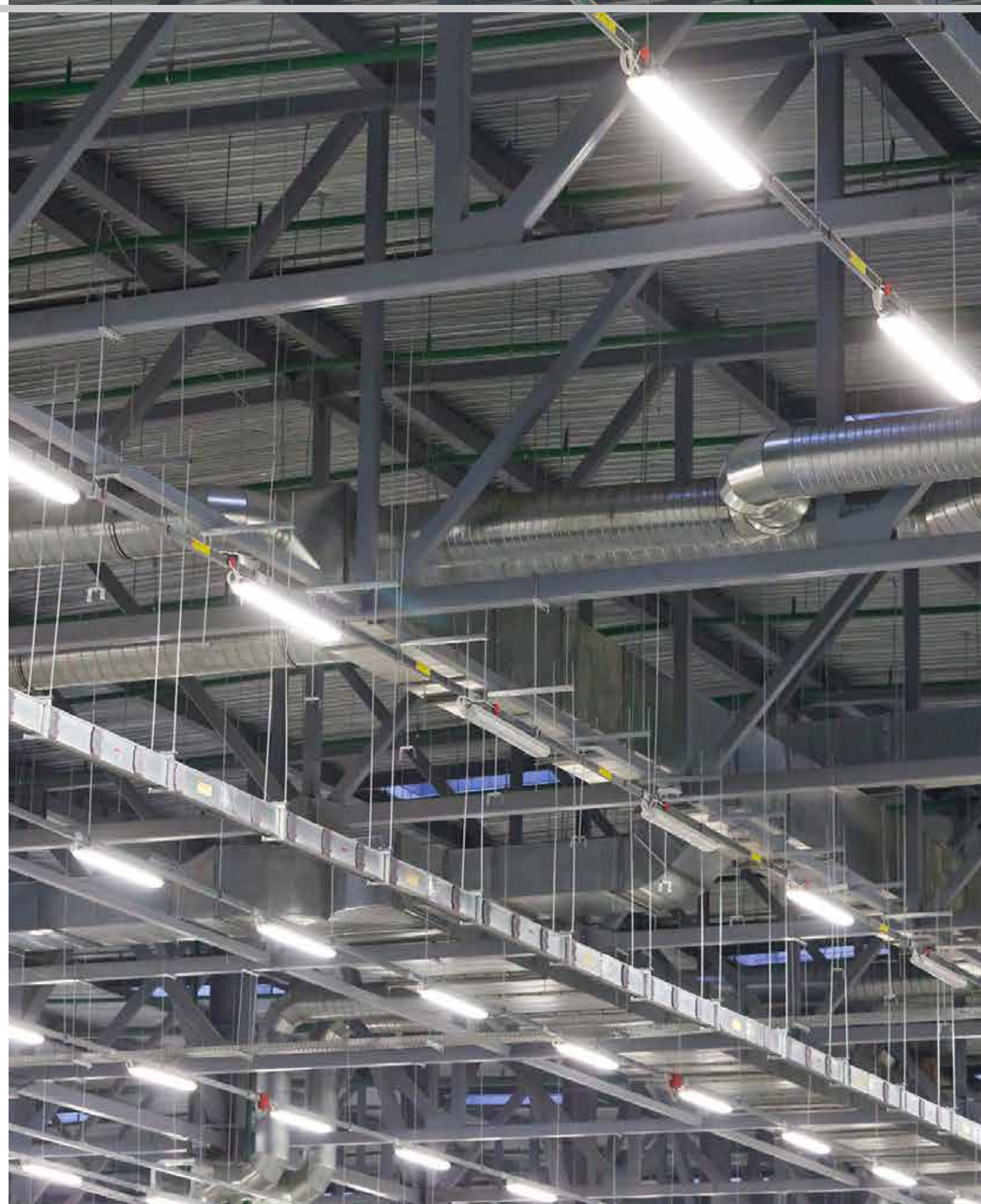

## ŞEFFAF ETANJ ARMATÜRLER



Sip. Kodu	Güc (W)	Işık Akısı (lm)	Renk Sıcaklığı (K)	Ölçüler (b/d)	Koli Adedi	Fiyat (₺)	Radar Sensörlü Fiyat (₺)	Acil Kitli Fiyat (₺)
760310	18	2250	3000	60/50/600	6	26,90	-	-
760311	18	2250	4000	60/50/600	6	26,90	-	-
760312	18	2250	6500	60/50/600	6	26,90	-	-
760320	36	4500	3000	60/50/1200	6	33,92	94,37	73,62
760321	36	4500	4000	60/50/1200	6	33,92	94,37	73,62
760322	36	4500	6500	60/50/1200	6	33,92	94,37	73,62
760330	65	8125	3000	60/50/1500	6	39,28	99,99	-
760331	65	8125	4000	60/50/1500	6	39,28	99,99	-
760332	65	8125	6500	60/50/1500	6	39,28	99,99	-

### Yüksek Güçlü

760340	95	9500	3000	60/50/1500	6	63,00	-	-
760341	95	9500	4000	60/50/1500	6	63,00	-	-
760342	95	9500	6500	60/50/1500	6	63,00	-	-

## ETANJ ARMATÜRLER



Sip. Kodu	Güc (W)	Işık Akısı (lm)	Renk Sıcaklığı (K)	Ölçüler (b/d)	Koli Adedi	Fiyat (₺)	Radar Sensörlü Fiyat (₺)	Acil Kitli Fiyat (₺)
760250	18	1800	3000	60/50/600	6	25,62	-	-
760251	18	1800	4000	60/50/600	6	25,62	-	-
760252	18	1800	6500	60/50/600	6	25,62	-	-
760260	36	3600	3000	60/50/1200	6	32,30	89,88	78,99
760261	36	3600	4000	60/50/1200	6	32,30	89,88	78,99
760262	36	3600	6500	60/50/1200	6	32,30	89,88	78,99
760270	65	6500	3000	60/50/1500	6	37,40	95,23	-
760271	65	6500	4000	60/50/1500	6	37,40	95,23	-
760272	65	6500	6500	60/50/1500	6	37,40	95,23	-
760540	95	9500	3000	60/50/1500	6	60,00	-	-
760541	95	9500	4000	60/50/1500	6	60,00	-	-
760542	95	9500	6500	60/50/1500	6	60,00	-	-

### Yüksek Güçlü

760360	44	4400	3000	60/50/1200	6	33,92	-	-
760361	44	4400	4000	60/50/1200	6	33,92	-	-
760362	44	4400	6500	60/50/1200	6	33,92	-	-

## İŞILDAK



Sip. Kodu	Renk Sıcaklığı (K)	Ölçüler (b/d)	Fiyat (₺)
710458	6500	60/50/300	16,00

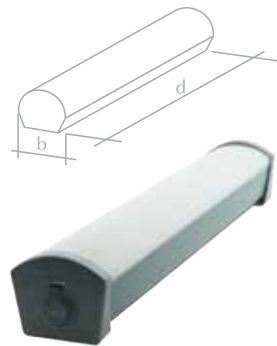
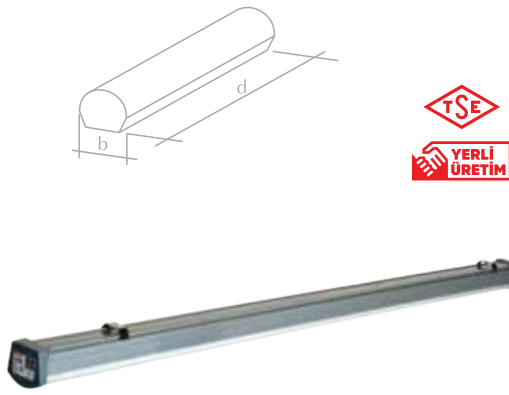
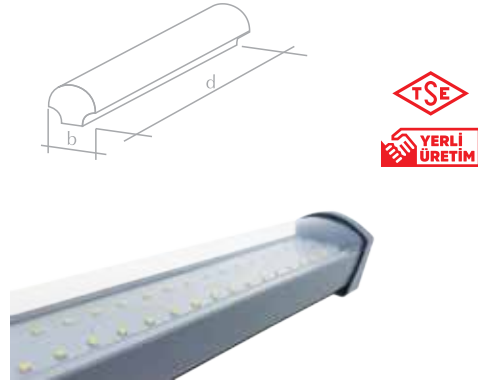

## YÜKSEK TAVAN ARMATÜRLER



Sip. Kodu	Güc (W)	Işık Akısı (lm)	Renk Sıcaklığı (K)	Garanti	Ölçüler (b/d)	Koli Adedi	Fiyat (₺)
750822	100	11000	6500	2 Yıl	35/245	1	57,20
750832	150	16500	6500	2 Yıl	35/280	1	70,60
750842	200	22000	6500	2 Yıl	35/330	1	84,00
<b>Sürücülü</b>							
750622	100	11000	6500	2 Yıl	75/245	1	66,70
750632	150	16500	6500	2 Yıl	75/280	1	100,00
750642	200	22000	6500	2 Yıl	75/330	1	120,00
<b>Enec Sürücülü</b>							
750722	100	11000	6500	3 Yıl	75/245	1	98,60
750732	150	16500	6500	3 Yıl	75/280	1	134,00
750742	200	22000	6500	3 Yıl	75/330	1	152,00

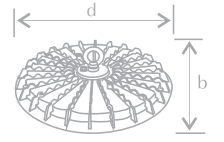

## PROJEKTÖRLER



Sip. Kodu	Güc (W)	Işık Akısı (lm)	Renk Sıcaklığı (K)	Ölçüler (b/d)	Koli Adedi	Fiyat (₺)
750400	10	1000	3000	98/80/28	30	11,00
750402	10	1000	6500	98/80/28	30	11,00
750403	10	-	Yeşil	98/80/28	30	11,55
750404	10	-	Amber	98/80/28	30	11,55
750405	10	-	RGB	98/80/28	30	26,00
750410	30	3000	3000	148/133/28	30	18,44
750412	30	3000	6500	148/133/28	30	18,44
750413	30	-	Yeşil	148/133/28	30	20,00
750414	30	-	Amber	148/133/28	30	20,00
750430	50	5000	3000	178/170/28	20	24,80
750432	50	5000	6500	178/170/28	20	24,80
750435	50	-	Yeşil	178/170/28	20	27,28
750450	100	10000	3000	250/250/30	10	38,50
750452	100	10000	6500	250/250/30	10	38,50
750460	150	15000	3000	330/275/35	5	75,00
750462	150	15000	6500	330/275/35	5	75,00
750470	200	20000	3000	390/310/35	5	98,20
750472	200	20000	6500	390/310/35	5	98,20
750490	300	30000	3000	421/307/45	3	187,00
750492	300	30000	6500	421/307/45	3	187,00
750591	400	40000	4000	460/340/50	2	280,00
750592	400	40000	6500	460/340/50	2	280,00
<b>Sensörlü</b>						
750442	30W	3000	6500	178/133/28	20	28,48

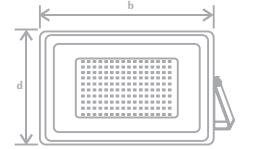



## 15 CM WALLWASHER



Sip. Kodu	Güç (W)	Işık Açısı	Işık Akısı (lm)	Renk Sıcaklığı (K)	Ölçüler (b/d)	Fiyat (₺)
770110	11	30	880	3000	60/50/150	69,12
770112	11	30	880	6500	60/50/150	69,12
770113	9	30	-	Kırmızı	60/50/150	73,14
770114	11	30	-	Mavi	60/50/150	73,14
770115	11	30	-	Yeşil	60/50/150	73,14
770116	9	30	-	Amber	60/50/150	73,14

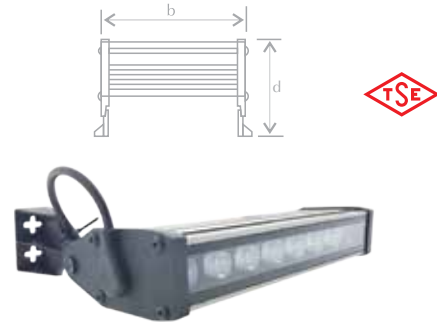

## 105 CM WALLWASHER



Sip. Kodu	Güç (W)	Işık Açısı	Işık Akısı (lm)	Renk Sıcaklığı (K)	Ölçüler (b/d)	Fiyat (₺)
770230	64	30	6250	3000	60/50/1050	195,84
770232	64	30	6250	6500	60/50/1050	195,84
770233	52	30	-	Kırmızı	60/50/1050	216,66
770234	64	30	-	Mavi	60/50/1050	216,66
770235	64	30	-	Yeşil	60/50/1050	216,66
770236	52	30	-	Amber	60/50/1050	216,66

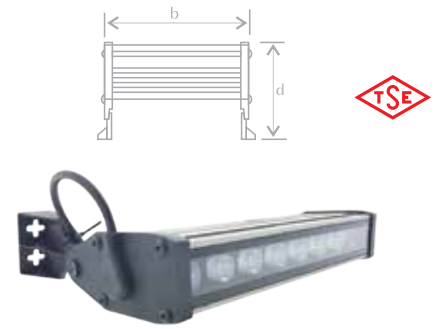

## 30 CM WALLWASHER



Sip. Kodu	Güç (W)	Işık Açısı	Işık Akısı (lm)	Renk Sıcaklığı (K)	Ölçüler (b/d)	Fiyat (₺)
770140	20	30	1900	3000	60/50/300	93,60
770142	20	30	1900	6500	60/50/300	93,60
770143	16	30	-	Kırmızı	60/50/300	98,68
770144	20	30	-	Mavi	60/50/300	98,68
770145	20	30	-	Yeşil	60/50/300	98,68
770146	16	30	-	Amber	60/50/300	98,68

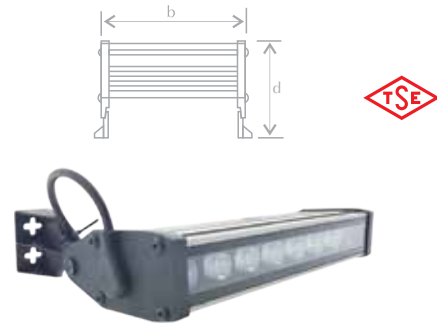

## 12 V / 15 CM WALLWASHER



Sip. Kodu	Güç (W)	Işık Açısı	Işık Akısı (lm)	Renk Sıcaklığı (K)	Ölçüler (b/d)	Fiyat (₺)
780110	11	30	880	3000	60/50/150	79,20
780112	11	30	880	6500	60/50/150	79,20
780113	9	30	-	Kırmızı	60/50/150	84,18
780114	11	30	-	Mavi	60/50/150	84,18
780115	11	30	-	Yeşil	60/50/150	84,18
780116	9	30	-	Amber	60/50/150	84,18

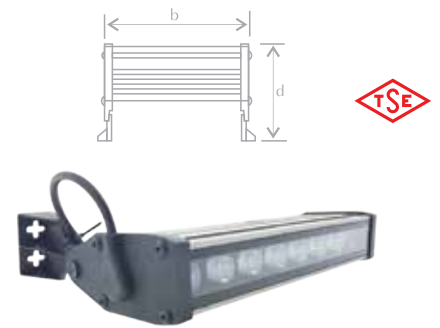

## 60 CM WALLWASHER



Sip. Kodu	Güç (W)	Işık Açısı	Işık Akısı (lm)	Renk Sıcaklığı (K)	Ölçüler (b/d)	Fiyat (₺)
770170	38	30	3600	3000	60/50/600	131,04
770172	38	30	3600	6500	60/50/600	131,04
770173	30	30	-	Kırmızı	60/50/600	144,22
770174	38	30	-	Mavi	60/50/600	144,22
770175	38	30	-	Yeşil	60/50/600	144,22
770176	30	30	-	Amber	60/50/600	144,22

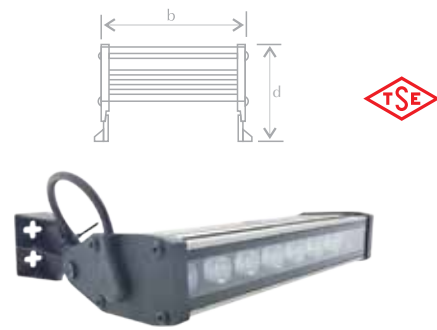

## 24 V / 30 CM WALLWASHER



Sip. Kodu	Güç (W)	Işık Açısı	Işık Akısı (lm)	Renk Sıcaklığı (K)	Ölçüler (b/d)	Fiyat (₺)
780140	20	30	1900	3000	60/50/300	108,00
780142	20	30	1900	6500	60/50/300	108,00
780143	16	30	-	Kırmızı	60/50/300	113,16
780144	20	30	-	Mavi	60/50/300	113,16
780145	20	30	-	Yeşil	60/50/300	113,16
780146	16	30	-	Amber	60/50/300	113,16

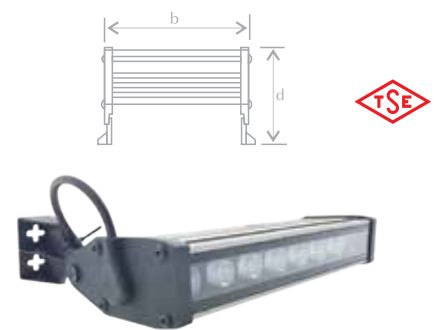

## TEK YÖNLÜ KÖŞELİ DUVAR ARMATÜRÜ



Sip. Kodu	Kasa Rengi	Ölçüler (b/d)	Koli Adedi	Fiyat (\$)
702103	Siyah	92x80x65	24	14,00
702203	Antrasit	92x80x65	24	14,00

## TEK YÖNLÜ OVAL DUVAR ARMATÜRÜ



Sip. Kodu	Kasa Rengi	Ölçüler (b/d)	Koli Adedi	Fiyat (\$)
702101	Siyah	92x80x65	24	13,74
702201	Antrasit	92x80x65	24	13,74
702301	Mat Saten	92x80x65	24	15,68

## BOMBELİ DUVAR ARMATÜRÜ



Sip. Kodu	Kasa Rengi	Ölçüler (b/d)	Koli Adedi	Fiyat (\$)
701106	Siyah	100x180x84	24	22,49
702206	Antrasit	100x180x84	24	22,49
702306	Mat Saten	100x180x84	24	25,11

## IŞIK SÜZMELİ ÇİFT YÖNLÜ OVAL DUVAR ARMATÜRÜ

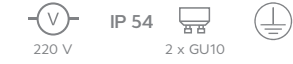

Sip. Kodu	Kasa Rengi	Ölçüler (b/d)	Koli Adedi	Fiyat (\$)
702124	Siyah	92x150x68	24	19,94
702224	Antrasit	92x150x68	24	19,94

## IŞIK SÜZMELİ TEK YÖNLÜ OVAL DUVAR ARMATÜRÜ



Sip. Kodu	Kasa Rengi	Ölçüler (b/d)	Koli Adedi	Fiyat (\$)
702123	Siyah	92x80x65	24	14,94
702223	Antrasit	92x80x65	24	14,94

## TEK YÖNLÜ SİLİNDİR DUVAR ARMATÜRÜ



Sip. Kodu	Kasa Rengi	Ölçüler (b/d)	Koli Adedi	Fiyat (\$)
701107	Siyah	92x150x68	24	19,94
701207	Antrasit	92x150x68	24	19,94
701307	Mat Saten	92x150x68	24	21,20

## ÇİFT YÖNLÜ SİLİNDİR ARMATÜRÜ



Sip. Kodu	Kasa Rengi	Ölçüler (b/d)	Koli Adedi	Fiyat (\$)
702108	Siyah	92x150x68	24	22,49
702208	Antrasit	92x150x68	24	22,49
702308	Mat Saten	92x150x68	24	25,11

## KAZIKLI ÇİM ARMATÜRÜ



Sip. Kodu	Kasa Rengi	Ölçüler (b/d)	Koli Adedi	Fiyat (\$)
701101	Siyah	95x270x90	24	15,23
701201	Antrasit	95x270x90	24	15,23

## ÇİFT YÖNLÜ KÖŞELİ DUVAR ARMATÜRÜ



Sip. Kodu	Kasa Rengi	Ölçüler (b/d)	Koli Adedi	Fiyat (\$)
702104	Siyah	92x150x68	24	19,94
702204	Antrasit	92x150x68	24	19,94

## ÇİFT YÖNLÜ OVAL DUVAR ARMATÜRÜ



Sip. Kodu	Kasa Rengi	Ölçüler (b/d)	Koli Adedi	Fiyat (\$)
702102	Siyah	92x150x68	24	18,85
702202	Antrasit	92x150x68	24	18,85
702302	Mat Saten	92x150x68	24	22,00

## ŞAPKALI KAZIKLI ÇİM ARMATÜRÜ

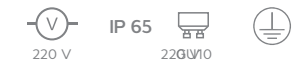

Sip. Kodu	Kasa Rengi	Ölçüler (b/d)	Koli Adedi	Fiyat (\$)
701302	Siyah	150x330x90	24	21,00
701301	Antrasit	150x330x90	24	21,00

## MONOFAZE RAY SPOT



Sip. Kodu	Kasa Rengi	Güç (W)	Işık Akısı (lm)	Renk Sıcaklığı (K)	Fiyat (₺)
760401	Siyah	30	3000	3000	43,25
760501	Beyaz	30	3000	3000	43,25
760407	Siyah	30	3000	3000	43,25
760507	Beyaz	30	3000	3000	43,25
760413	Siyah	30	3000	3000	47,12
760513	Beyaz	40	3000	3000	47,12
760419	Siyah	40	4000	3000	49,07
760519	Beyaz	40	4000	3000	49,07
760426	Siyah	40	4000	3000	49,04
760526	Beyaz	40	4000	3000	49,04
760431	Siyah	40	4000	3000	42,80
760531	Beyaz	40	4000	3000	42,80



## TRİFAZE RAY SOKETLERİ

Sip. Kodu	Kasa Rengi	Fiyat (₺)
730134	Siyah	5,00
730135	Beyaz	5,00



## MONOFAZE RAY

Sip. Kodu	Uzunluk	Renk	Fiyat (₺)
730100	1	Siyah	8,06
730101	2	Siyah	16,12
730102	3	Siyah	24,19
730103	1	Beyaz	8,06
730104	2	Beyaz	16,12
730105	3	Beyaz	24,19



## MONOFAZE ARABAĞLANTI APARATI

Sip. Kodu	Renk	Fiyat (₺)
730108	Siyah	1,69
730109	Beyaz	1,69



## MONOFAZE L KÖŞE APARAT

Sip. Kodu	Renk	Fiyat (₺)
730114	Siyah	3,05
730115	Beyaz	3,05



## MONOFAZE T APARAT

Sip. Kodu	Renk	Fiyat (₺)
730106	Siyah	9,50
730107	Beyaz	9,50



## MONOFAZE SONLANDIRMA APARATI

Sip. Kodu	Renk	Fiyat (₺)
730112	Siyah	1,25
730113	Beyaz	1,25



## MONOFAZE ENERJİ GİRİŞ APARATI

Sip. Kodu	Renk	Fiyat (₺)
730110	Siyah	3,20
730111	Beyaz	3,20



## PANEL ARMATÜRLER

Sip. Kodu	Güç (W)	Işık Akısı (lm)	Renk Sıcaklığı (K)	Koli Adedi	Ölçüler (b/d)	Yükseklik (cm)	Fiyat (₺)
<b>Taşıyünü / Sıva Altı / Dahili Sürücülü</b>							
760253	12	1480	3000	40	30/30	3	8,00
760256	12	1480	6500	40	30/30	3	8,00
760483	48	4800	3000	5	60/60	5	24,00
760484	48	4800	4000	5	60/60	5	24,00
760486	48	4800	6500	5	60/60	5	24,00
<b>Taşıyünü / Sıva Altı</b>							
760489	48	4800	3000	8	60/60	3	21,00
760490	48	4800	4000	8	60/60	3	21,00
760491	48	4800	6500	8	60/60	3	21,00
<b>Alçıpan</b>							
760497	48	4800	3000	8	60/60	8	27,22
760498	48	4800	4000	8	60/60	8	27,22
760499	48	4800	6500	8	60/60	8	27,22
<b>Sıva Üstü</b>							
760493	48	4800	3000	8	60/60	5	Fiyat Sorunuz
760494	48	4800	4000	8	60/60	5	Fiyat Sorunuz
760495	48	4800	6500	8	60/60	5	Fiyat Sorunuz

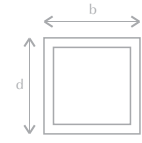

## PANEL KASALARI

Sip. Kodu	Ölçüler (b/d)	Yükseklik (cm)	Fiyat (₺)
<b>Sıva Üstü</b>			
710700	30/30	5	4,80
710760	60/60	5	11,00
710775	60/60	8	19,80
<b>Clip-in</b>			
710710	30/30	2,5	4,80
710770	60/60	2,5	15,32
<b>Alçıpan Yay Takımı</b>			
710765	30*30 ve 60*60 uyumludur		0,67

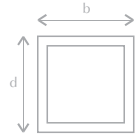

## SIVA ÜSTÜ SENSÖRLÜ LED TAVAN ARMATÜRLERİ

Sip. Kodu	Güç (W)	Işık Akısı (lm)	Renk Sıcaklığı (K)	Koli Adedi	Ölçüler (b/d)	Fiyat (₺)
<b>Acil Kitli</b>						
702186	18	2200	6500	10	300/95	15,82
712186	18	2200	6500	10	300/95	20,34

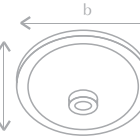

## ENEC SÜRÜCÜLÜ PANEL ARMATÜRLER

Sip. Kodu	Güç (W)	Işık Akısı (lm)	Renk Sıcaklığı (K)	Koli Adedi	Garanti	Ölçüler (b/d)	Yükseklik (cm)	Fiyat (₺)
<b>Taşıyünü / Sıva Altı</b>								
760471	48	4800	3000	8	3 Yıl	60/60	3	31,00
760472	48	4800	4000	8	3 Yıl	60/60	3	31,00
760473	48	4800	6500	8	3 Yıl	60/60	3	31,00
<b>Alçıpan</b>								
760479	48	4800	3000	8	3 Yıl	60/60	8	37,00
760480	48	4800	4000	8	3 Yıl	60/60	8	37,00
760481	48	4800	6500	8	3 Yıl	60/60	8	37,00
<b>Sıva Üstü</b>								
760475	48	4800	3000	8	3 Yıl	60/60	5	Fiyat Sorunuz
760476	48	4800	4000	8	3 Yıl	60/60	5	Fiyat Sorunuz
760477	48	4800	6500	8	3 Yıl	60/60	5	Fiyat Sorunuz

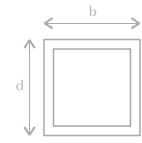

## SIVA ÜSTÜ SENSÖRLÜ CAM TAVAN ARMATÜRLERİ

Sip. Kodu	Güç (W)	Işık Akısı (lm)	Renk Sıcaklığı (K)	Koli Adedi	Ölçüler (b/d)	Fiyat (₺)
<b>Ledli</b>						
702196	18	2200	6500	10	300/95	17,10
<b>2xE27 Duyulu</b>						
702191	18	2200	6500	10	300/95	12,80

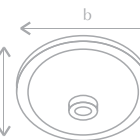

## SIVA ÜSTÜ LED TAVAN ARMATÜRÜ



Sip. Kodu	Güç (W)	Işık Akısı (lm)	Renk Sıcaklığı (K)	Koli Adedi	Ölçüler (b/d)	Fiyat (₺)
702194	22	1700	6500	10	300/95	10,47

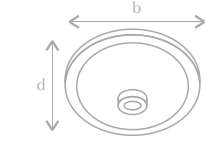

## SIVA ÜSTÜ KARE PANEL ARMATÜRLER



Sip. Kodu	Güç (W)	Işık Akısı (lm)	Kasa Rengi	Renk Sıcaklığı (K)	Koli Adedi	Ölçüler (b/d)	Yükseklik (cm)	Fiyat (₺)
710233	18	1620	Beyaz	3000	30	205/205	2,5	8,80
710236	18	1620	Beyaz	6500	30	205/205	2,5	8,80
710243	24	1920	Beyaz	3000	10	275/275	3,5	13,28
710246	24	1920	Beyaz	6500	10	275/275	3,5	13,28
710343	24	1920	Siyah	3000	10	275/275	3,5	13,94
710346	24	1920	Siyah	6500	10	275/275	3,5	13,94

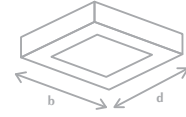

## SIVA ÜSTÜ YUVARLAK PANEL ARMATÜRLER



Sip. Kodu	Güç (W)	Işık Akısı (lm)	Kasa Rengi	Renk Sıcaklığı (K)	Koli Adedi	Ölçüler (b/d)	Yükseklik (cm)	Fiyat (₺)
711223	18	1620	Beyaz	3000	30	205/205	2,5	8,00
711226	18	1620	Beyaz	6500	30	205/205	2,5	8,00
711243	24	1920	Beyaz	3000	10	275/275	3,5	11,40
711246	24	1920	Beyaz	6500	10	275/275	3,5	11,40
712243	24	1920	Siyah	3000	10	275/275	3,5	11,97
712246	24	1920	Siyah	6500	10	275/275	3,5	11,97

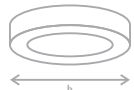

## SIVA ALTI PANEL ARMATÜRLER



Sip. Kodu	Güç (W)	Işık Akısı (lm)	Renk Sıcaklığı (K)	Koli Adedi	İç Çap (mm)	Dış Çap (mm)	Fiyat (₺)
710033	3	270	3000	90	65	80	3,13
710034	3	270	4000	90	65	80	3,13
710036	3	270	6500	90	65	80	3,13
710063	6	540	3000	80	95	120	3,50
710064	6	540	4000	80	95	120	3,50
710066	6	540	6500	80	95	120	3,50
710093	9	810	3000	90	120	150	4,34
710094	9	810	4000	90	120	150	4,34
710096	9	810	6500	90	120	150	4,34
710123	12	1080	3000	60	142	170	4,78
710124	12	1080	4000	60	142	170	4,78
710126	12	1080	6500	60	142	170	4,78
710153	15	1350	3000	20	170	190	5,73
710154	15	1350	4000	20	170	190	5,73
710156	15	1350	6500	20	170	190	5,73
710183	18	1620	3000	40	192	230	6,10
710184	18	1620	4000	40	192	230	6,10
710186	18	1620	6500	40	192	230	6,10

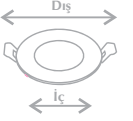

## YATAY LED BANT ARMATÜR



Sip. Kodu	Güç (W)	Işık Akısı (lm)	Renk Sıcaklığı (K)	Ölçüler (b/d)	Koli Adedi	Fiyat (₺)
710200	36	3600	3000	72/1277	30	12,70
710201	36	3600	4000	72/1277	30	12,70
710202	36	3600	6500	72/1277	30	12,70



## T5 BANT ARMATÜRLER



Sip. Kodu	Güç (W)	Işık Akısı (lm)	Renk Sıcaklığı (K)	Ölçüler (b/d)	Koli Adedi	Fiyat (₺)
710411	9	900	3000	22/600	25	6,50
710412	9	900	4000	22/600	25	6,50
710413	9	900	6500	22/600	25	6,50
710414	18	1800	3000	22/1200	25	9,70
710415	18	1800	4000	22/1200	25	9,70
710416	18	1800	6500	22/1200	25	9,70





### SOKAK ARMATÜRÜ



Sip. Kodu	Güç (W)	Işık Akısı (lm)	Renk Sıcaklığı (K)	Ölçüler (b/d)	Koli Adedi	Fiyat (₺)
750900	50	5000	6500	131/300	1	51,63
750902	100	10000	6500	147/360	1	59,00
750904	150	15000	6500	167/420	1	70,00



**YERLİ ÜRETİM**

### FOTOSELLİ SOKAK ARMATÜRÜ



Sip. Kodu	Güç (W)	Işık Akısı (lm)	Renk Sıcaklığı (K)	Ölçüler (b/d)	Koli Adedi	Fiyat (₺)
750901	50	5000	6500	131/300	1	52,40
750903	100	10000	6500	147/360	1	61,16
750905	150	15000	6500	167/420	1	72,84



**YERLİ ÜRETİM**

### SOLAR KAZIKLI ÇİM ARMATÜRÜ



Sip. Kodu	Güç (W)	Işık Akısı (lm)	Renk Sıcaklığı (K)	Ölçüler (b/d)	Koli Adedi	Fiyat (₺)
703201	1	100	3000	215/377	50	18,87
703202	1	100	6500	215/377	50	18,87
703203	1	100	Yeşil	215/377	50	18,87
703204	1	100	Amber	215/377	50	18,87



### SOLAR SET ÜSTÜ ARMATÜRLER



Sip. Kodu	Güç (W)	Işık Akısı (lm)	Renk Sıcaklığı (K)	Ölçüler (b/d)	Koli Adedi	Fiyat (₺)
703101	2	300	3000	160/213	10	25,75
703102	2	300	6500	160/213	10	25,75
703103	2	300	RGB	160/213	10	28,42

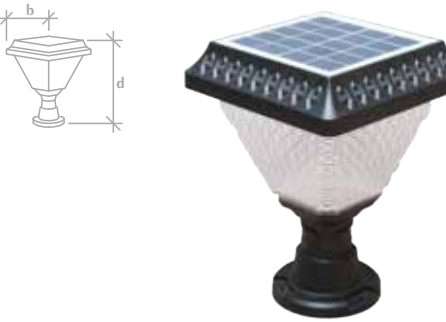

## ŞARJLI - MANTAR MASA LAMBASI

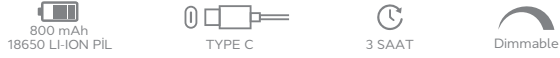

Sip. Kodu	Güç (W)	Işık Akısı (lm)	Renk Sıcaklığı (K) 3 Kademeli	Kasa Rengi	Koli Adedi	Ölçüler (b/d)	Fiyat (\$)
710470	2	110	6500 - 3200 - Amber	Altın	40	100/220	14,82
710471	2	110	6500 - 3200 - Amber	Bakır	40	100/220	14,82



## ŞARJLI - KADEMELİ MASA LAMBASI



Sip. Kodu	Güç (W)	Işık Akısı (lm)	Renk Sıcaklığı (K) 3 Kademeli	Kasa Rengi	Koli Adedi	Ölçüler (b/d)	Fiyat (\$)
710476	2	200	6500 - 4000 - 3000	Altın	20	116/360	25,53
710477	2	200	6500 - 4000 - 3000	Beyaz	40	116/360	17,76
710478	2	200	6500 - 4000 - 3000	Siyah	40	116/360	17,76



## ŞARJLI - AKRİLİK MASA LAMBASI

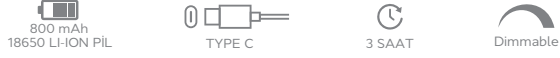

Sip. Kodu	Güç (W)	Işık Akısı (lm)	Renk Sıcaklığı (K) 3 Kademeli	Kasa Rengi	Koli Adedi	Ölçüler (b/d)	Fiyat (\$)
710472	2	110	6500 - 3200 - Amber	Altın	40	90/210	15,41
710473	2	110	6500 - 3200 - Amber	Bakır	40	90/210	15,41



## FLÜT APLİK



Sip. Kodu	Güç (W)	Işık Akısı (lm)	Renk Sıcaklığı (K)	Kasa Rengi	Ölçüler (b/d)	Fiyat (\$)
720910	9	850	3000	Antrasit	430/230	25,60
720911	9	850	4000	Antrasit	430/230	25,60
720912	9	850	6500	Antrasit	430/230	25,60
720920	9	850	3000	Krom	430/230	33,00
720921	9	850	4000	Krom	430/230	33,00
720922	9	850	6500	Krom	430/230	33,00
720930	9	850	3000	Gold	430/230	33,00
720931	9	850	4000	Gold	430/230	33,00
720932	9	850	6500	Gold	430/230	33,00



## ŞARJLI - UFO MASA LAMBASI

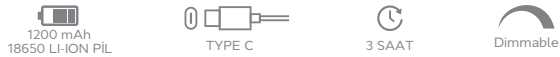

Sip. Kodu	Güç (W)	Işık Akısı (lm)	Renk Sıcaklığı (K) 3 Kademeli	Kasa Rengi	Koli Adedi	Ölçüler (b/d)	Fiyat (\$)
710474	2	200	6500 - 4000 - 3000	Altın	20	125/280	24,84
710475	2	200	6500 - 4000 - 3000	Bakır	20	125/280	24,84



## DEKORATİF APLİK



Sip. Kodu	Güç (W)	Işık Akısı (lm)	Renk Sıcaklığı (K)	Kasa Rengi	Ölçüler (b/d)	Fiyat (\$)
721110	11	1050	3000	Antrasit	570/45/60	28,20
721111	11	1050	4000	Antrasit	570/45/60	28,20
721112	11	1050	6500	Antrasit	570/45/60	28,20
721120	11	1050	3000	Krom	570/45/60	36,00
721121	11	1050	4000	Krom	570/45/60	36,00
721122	11	1050	6500	Krom	570/45/60	36,00
721130	11	1050	3000	Gold	570/45/60	36,00
721131	11	1050	4000	Gold	570/45/60	36,00
721132	11	1050	6500	Gold	570/45/60	36,00





### SIVA ÜSTÜ YUVARLAK VE KARE SPOT KASALARI

Sip. Kodu	Ölçüler (b/d)	Kasa Tipi	Kasa Rengi	Reflektör Rengi	Koli Adedi	Acil Kitli Fiyat (\$)
720150	95/100	Yuvarlak	Siyah	Siyah	50	5,88
720151	95/100	Yuvarlak	Beyaz	Beyaz	50	5,88
720152	95/100	Yuvarlak	Siyah	Mat Bronz	50	6,20
720154	95/100	Kare	Siyah	Siyah	50	6,30
720155	95/100	Kare	Beyaz	Beyaz	50	6,30
720156	95/100	Kare	Siyah	Mat Bronz	50	6,72



### SIVA ÜSTÜ 2'Lİ KARE SPOT KASALARI

Sip. Kodu	Ölçüler (b/d)	Kasa Rengi	Reflektör Rengi	Koli Adedi	Acil Kitli Fiyat (\$)
720158	180/100	Siyah	Siyah	30	12,60
720159	180/100	Beyaz	Beyaz	30	12,60
720160	180/100	Siyah	Mat Bronz	30	13,44



### SIVA ALTI YUVARLAK VE KARE SPOT KASALARI

Sip. Kodu	Ölçüler (b/d)	Kasa Tipi	Kasa Rengi	Reflektör Rengi	Koli Adedi	Montaj Ölçüsü	Acil Kitli Fiyat (\$)
720162	90/30	Yuvarlak	Siyah	Siyah	100	75 mm	2,35
720163	90/30	Yuvarlak	Siyah	Beyaz	100	75 mm	2,35
720164	90/30	Yuvarlak	Siyah	Mat Bronz	100	75 mm	2,63
720166	92/30	Kare	Siyah	Siyah	100	75 mm	2,44
720167	92/30	Kare	Siyah	Beyaz	100	75 mm	2,44
720168	92/30	Kare	Siyah	Mat Bronz	100	75 mm	2,73

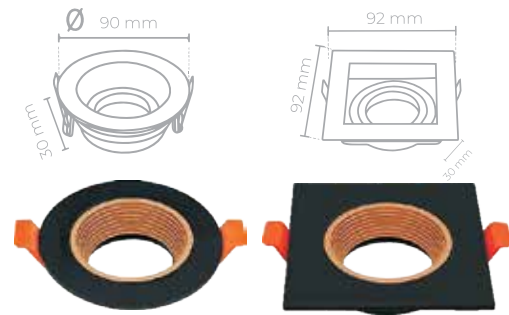

## A60 LED LAMBALAR



Sip. Kodu	Güç (W)	Işık Akısı (lm)	Renk Sıcaklığı (K)	Koli Adedi	Ölçüler (b/d)	Fiyat (₺)
500114	8	800	3000	100	107/60	1,45
500115	8	800	6500	100	107/60	1,45
500121	12	1055	4000	100	120/60	1,95
500130	14	1400	3000	100	123/60	2,64
500132	14	1400	6000	100	123/60	2,64

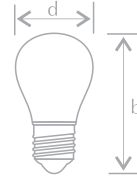

## KIVRIK BUJİ LED LAMBALAR



Sip. Kodu	Güç (W)	Işık Akısı (lm)	Renk Sıcaklığı (K)	Koli Adedi	Ölçüler (b/d)	Fiyat (₺)
500225	5,5	470	3000	100	133/37	1,86
500227	5,5	420	6500	100	133/37	1,86

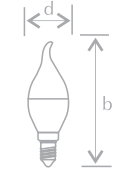

## TORCH LED LAMBALAR



Sip. Kodu	Güç (W)	Işık Akısı (lm)	Renk Sıcaklığı (K)	Koli Adedi	Kasa Tipi	Ölçüler (b/d)	Fiyat (₺)
500170	20	2100	6500	48	1	148,5/80	3,90
500171	20	2100	6500	48	2	148,5/80	3,90
500172	20	2100	6500	48	3	148,5/80	3,90
500173	30	3200	6500	30	1	174,5/100	5,12
500174	30	3200	6500	30	2	174,5/100	5,12
500175	30	3200	6500	30	3	174,5/100	5,12
500176	40	4300	6500	16	1	195,5/115	7,22
500177	40	4300	6500	16	2	195,5/115	7,22
500178	40	4300	6500	16	3	195,5/115	7,22
500179	50	5400	6500	12	1	218,2/120	9,60
500180	50	5400	6500	12	2	218,2/120	9,60
500181	50	5400	6500	12	3	218,2/120	9,60
500182	60	6500	6500	8	1	238,6/135	12,45
500183	60	6500	6500	8	2	238,6/135	12,45
500184	60	6500	6500	8	3	238,6/135	12,45

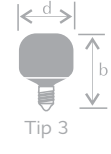
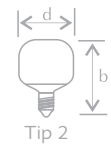
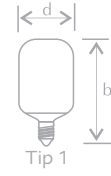

## P45 TOP LED LAMBALAR



Sip. Kodu	Güç (W)	Işık Akısı (lm)	Renk Sıcaklığı (K)	Koli Adedi	Ölçüler (b/d)	Fiyat (₺)
500262	4	280	6500	100	78/45	1,73

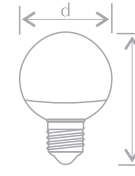

## BUJİ LED LAMBALAR



Sip. Kodu	Güç (W)	Işık Akısı (lm)	Renk Sıcaklığı (K)	Duy	Koli Adedi	Ölçüler (b/d)	Fiyat (₺)
500713	7	595	3000	E14	100	100/37	1,78
500715	7	595	6500	E14	100	100/37	1,78
500216	5	425	3000	E27	100	100/37	1,95
500218	5	425	6500	E27	100	100/37	1,95

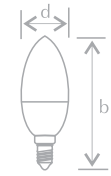

## GU10 MR 16 LED LAMBALAR



Sip. Kodu	Güç (W)	Işık Akısı (lm)	Renk Sıcaklığı (K)	Koli Adedi	Ölçüler (b/d)	Fiyat (₺)
500303	6	510	3000	100	50/57	1,75
500304	6	510	4000	100	50/57	1,75
500305	6	510	6500	100	50/57	1,75

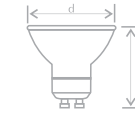



## LENSLİ GU10 MR 16 LED LAMBALAR



Sip. Kodu	Güç (W)	Işık Akısı (lm)	Renk Sıcaklığı (K)	Koli Adedi	Ölçüler (b/d)	Fiyat (₺)
500317	7	-	Yeşil	100	50/58	2,00
500403	7	-	Kırmızı	100	50/58	2,00
500405	7	-	Mavi	100	50/58	2,00
500404	7	630	4000	100	50/58	1,75
500407	7	630	6500	100	50/58	1,75
500408	7	630	3000	100	50/58	1,75

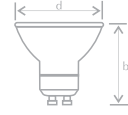

## R63 SPOT LED LAMBALAR



Sip. Kodu	Güç (W)	Işık Akısı (lm)	Renk Sıcaklığı (K)	Koli Adedi	Ölçüler (b/d)	Fiyat (₺)
500362	8	620	6500	100	100/63	3,80



## GU5.3 MR 16 LED LAMBALAR



Sip. Kodu	Güç (W)	Işık Akısı (lm)	Renk Sıcaklığı (K)	Duy	Koli Adedi	Ölçüler (b/d)	Fiyat (₺)
500312	4,5	220	6500	100	100	52/50	2,78

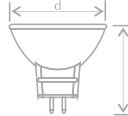

## PAR 20 SPOT LED LAMBALAR



Sip. Kodu	Güç (W)	Işık Akısı (lm)	Renk Sıcaklığı (K)	Koli Adedi	Ölçüler (b/d)	Fiyat (₺)
500370	7	508	3000	50	85/65	7,20
500372	7	508	6000	50	85/65	7,20

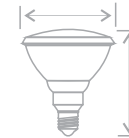

## R50 SPOT LED LAMBALAR



Sip. Kodu	Güç (W)	Işık Akısı (lm)	Renk Sıcaklığı (K)	Koli Adedi	Ölçüler (b/d)	Fiyat (₺)
500355	6	400	3000	100	86/50	2,78
500357	6	420	6500	100	86/50	2,78

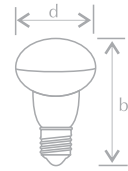

## PAR 30 SPOT LED LAMBALAR



Sip. Kodu	Güç (W)	Işık Akısı (lm)	Renk Sıcaklığı (K)	Koli Adedi	Ölçüler (b/d)	Fiyat (₺)
500376	12	870	3000	50	96/96	8,90
500379	12	870	6500	50	96/96	8,90

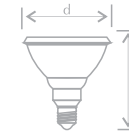

## G9 KAPSÜL LED LAMBA

Sip. Kodu	Güç (W)	Işık Akısı (lm)	Renk Sıcaklığı (K)	Koli Adedi	Ölçüler (b/d)	Fiyat (₺)
500342	2	102	6500	100	42/24	2,80

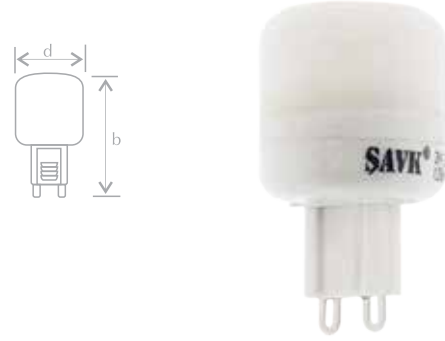

## T8 LED TÜP LAMBALAR

Sip. Kodu	Güç (W)	Işık Akısı (lm)	Renk Sıcaklığı (K)	Koli Adedi	Ölçüler (b/d)	Fiyat (₺)
500830	9	900	3000	25	600/28	4,90
500831	9	900	4000	25	600/28	4,90
500832	9	900	6500	25	600/28	4,90
500833	18	1800	3000	25	1200/28	6,45
500834	18	1800	4000	25	1200/28	6,45
500835	18	1800	6500	25	1200/28	6,45
500820	22	2265	6500	25	1500/28	9,00

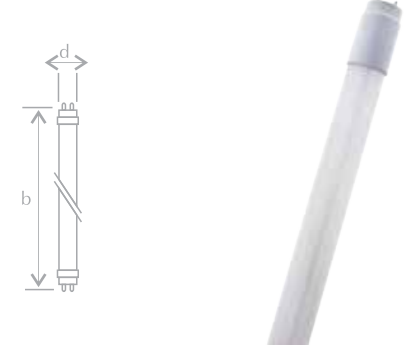

## SEKİZGEN LED LAMBA

Sip. Kodu	Güç (W)	Işık Akısı (lm)	Renk Sıcaklığı (K)	Koli Adedi	Ölçüler (b/d)	Fiyat (₺)
500267	36	3420	6500	20	250/110	8,60
500269	36	3420	3000	20	250/110	8,60



## A60 FİLAMANLI LED LAMBALAR

Sip. Kodu	Güç (W)	Işık Akısı (lm)	Renk Sıcaklığı (K)	Koli Adedi	Ölçüler (b/d)	Fiyat (₺)
500523	6	600	2200	50	106/60	4,51
Kısıtlanabilir						
500513	6	600	2200	50	106/60	5,40

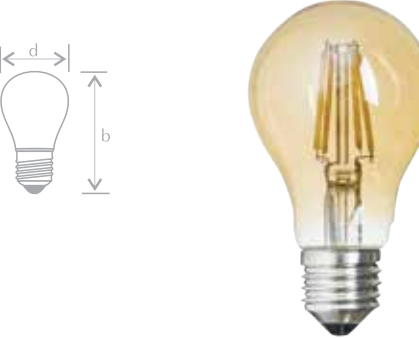

## LED UFO LAMBA

Sip. Kodu	Güç (W)	Işık Akısı (lm)	Renk Sıcaklığı (K)	Koli Adedi	Ölçüler (b/d)	Fiyat (₺)
500268	36	3600	6500	20	90/215	9,45
500270	36	3600	3000	20	90/215	9,45



## GLOP FİLAMANLI LED LAMBALAR

Sip. Kodu	Güç (W)	Işık Akısı (lm)	Renk Sıcaklığı (K)	Koli Adedi	Ölçüler (b/d)	Fiyat (₺)
500552	8	800	2200	50	165/125	8,00
500555	6	600	2200	50	165/95	5,81

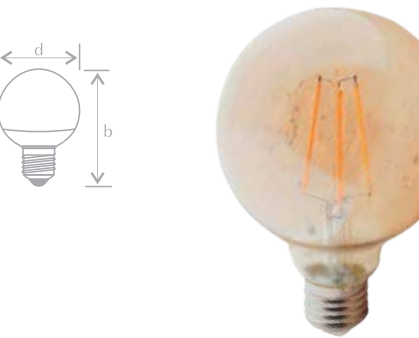

## TOP FİLAMANLI LED LAMBA

Sip. Kodu	Güç (W)	Işık Akısı (lm)	Renk Sıcaklığı (K)	Koli Adedi	Ölçüler (b/d)	Fiyat (₺)
500565	4	380	2200	100	74/45	3,15

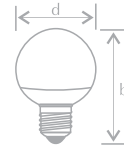

## KIVRIK BUJİ FİLAMANLI LED LAMBA

Sip. Kodu	Güç (W)	Işık Akısı (lm)	Renk Sıcaklığı (K)	Koli Adedi	Ölçüler (b/d)	Fiyat (₺)
500625	4	340	2700	50	123/35	2,95

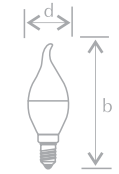

## T25 FİLAMANLI LED LAMBALAR

Sip. Kodu	Güç (W)	Işık Akısı (lm)	Renk Sıcaklığı (K)	Koli Adedi	Ölçüler (b/d)	Fiyat (₺)
500584	2	200	2700	50	85/25	3,23
500587	4	400	2700	50	125/25	3,92



## T32 FİLAMANLI LED LAMBA

Sip. Kodu	Güç (W)	Işık Akısı (lm)	Renk Sıcaklığı (K)	Koli Adedi	Ölçüler (b/d)	Fiyat (₺)
500652	4	300	2700	50	32/125	4,48

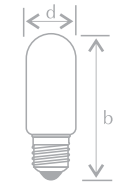

## BUJİ FİLAMANLI LED LAMBALAR

Sip. Kodu	Güç (W)	Işık Akısı (lm)	Renk Sıcaklığı (K)	Koli Adedi	Ölçüler (b/d)	Fiyat (₺)
500610	4	340	2700	50	99/35	2,20
500612	4	470	6500	50	100/35	2,70
500620	4	380	2700	50	100/35	2,85
<b>Kısılabılır</b>						
500621	4	350	2700	50	100/35	3,00



## ST64 FİLAMANLI LED LAMBALAR

Sip. Kodu	Güç (W)	Işık Akısı (lm)	Renk Sıcaklığı (K)	Koli Adedi	Ölçüler (b/d)	Fiyat (₺)
500670	4	380	2200	100	138/64	4,35
500673	6	660	3000	100	145/64	3,80
500674	6	660	6500	100	145/64	3,80
<b>Kısılabılır</b>						
500672	6	660	2200	100	145/64	6,34

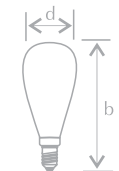



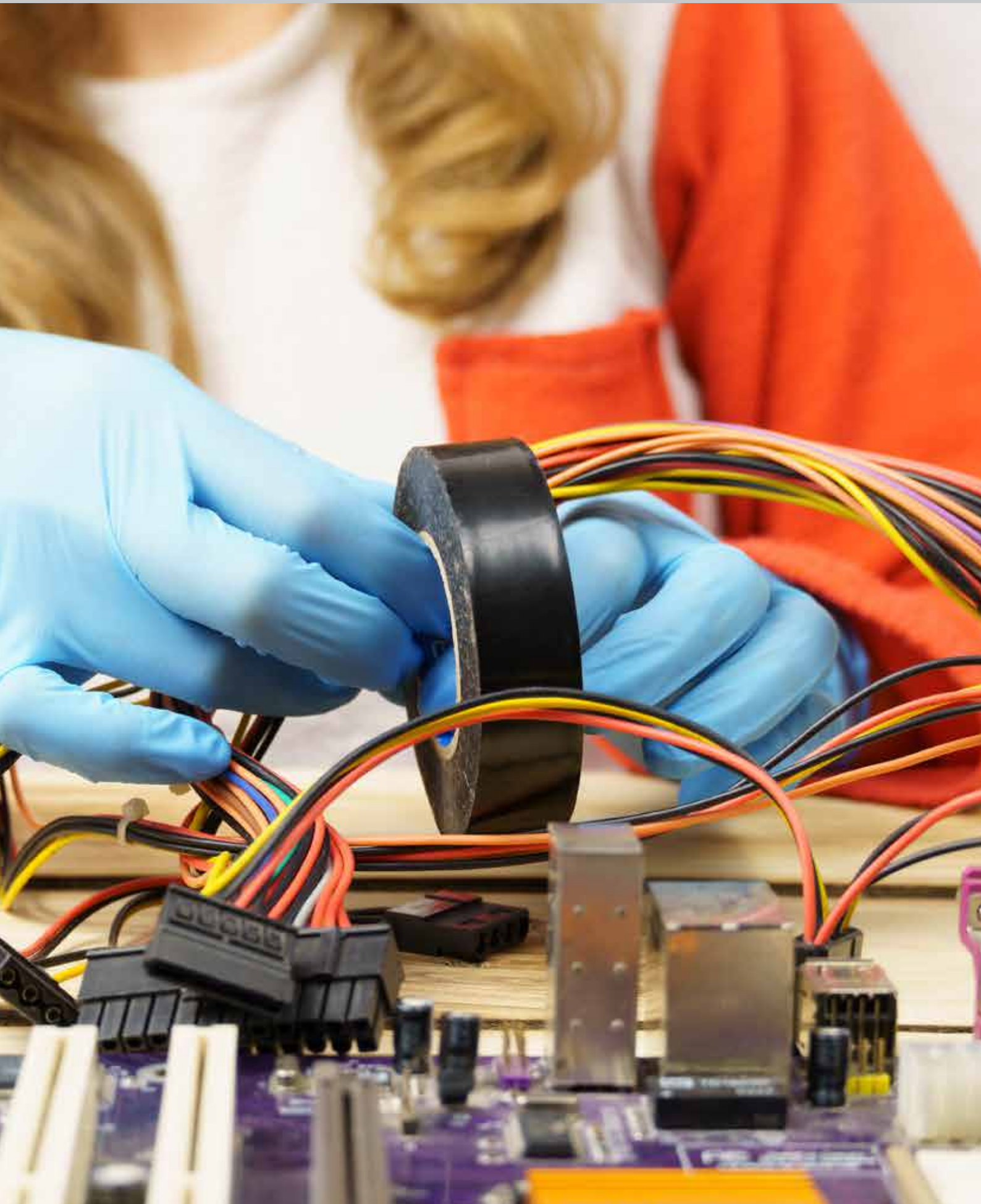

### PVC ELEKTRİK İZOLASYON BANTLARI

Sipariş Kodu	Renk	Genişlik (mm)	Rulo Uzunluğu (M)	Koli Miktarı (Rulo)	Fiyat (₺)
800100	Siyah	19	9,1	500	0,54
800101	Beyaz	19	9,1	500	0,54
800102	Kırmızı	19	9,1	500	0,54
800103	Mavi	19	9,1	500	0,54
800104	Yeşil	19	9,1	500	0,54
800105	Sarı	19	9,1	500	0,54
800106	Gri	19	9,1	500	0,54
800107	Sarı/Yeşil	19	9,1	500	0,60
800110	Siyah	50	22,8	48	2,94



### KENDİNDEN ERİYEN BANTLAR

Sipariş Kodu	Renk	Genişlik (mm)	Rulo Uzunluğu (M)	Koli Miktarı (Rulo)	Fiyat (₺)
800200	Siyah	19	8	60	2,36
800210	Siyah	50	8	24	6,20



### PVC DEKORATİF BANTLAR

Sipariş Kodu	Renk	Sarım	Genişlik (mm)	Rulo Uzunluğu (M)	Koli Miktarı (Rulo)	Fiyat (₺)
800300	Beyaz	Dar	50	18	100	1,80
800301	Beyaz	Geniş	50	18	100	1,80







## TEK ÇİPLİ İÇ MEKAN ŞERİT LEDLER



Sip. Kodu	Güç (W)	Işık Akısı (lm)	Renk Sıcaklığı (K)	Koli Adedi	Fiyat (₺)
201101	4,8	400	6500	250	0,80
201103	4,8	-	Kırmızı	250	0,80
201105	4,8	-	Yeşil	250	0,80
201106	4,8	-	Amber	250	1,02



## AURALED İÇ MEKAN ŞERİT LEDLER



Sip. Kodu	Güç (W)	Işık Akısı (lm)	Renk Sıcaklığı (K)	Koli Adedi	Fiyat (₺)
101102	14,4	500	6500	250	1,77



## ÜÇ ÇİPLİ İÇ MEKAN ŞERİT LEDLER



Sip. Kodu	Güç (W)	Işık Akısı (lm)	Renk Sıcaklığı (K)	Koli Adedi	Fiyat (₺)
200621	10	500	6500	200	1,00
200629	10	500	4000	200	1,00
200622	10	500	3000	200	1,00
200624	10	-	Mavi	200	1,00
200626	10	-	Amber	200	1,00



## TEK ÇİPLİ 120 LEDLİ İÇ MEKAN ŞERİT LEDLER



Sip. Kodu	Güç (W)	Işık Akısı (lm)	Renk Sıcaklığı (K)	Koli Adedi	Fiyat (₺)
99558	9,6	800	3000	250	2,57
99559	9,6	800	6000	250	2,57
99561	9,6	800	4000	250	2,57



## ÜÇ ÇİPLİ İÇ MEKAN ŞERİT LEDLER



Sip. Kodu	Güç (W)	Işık Akısı (lm)	Renk Sıcaklığı (K)	Koli Adedi	Fiyat (₺)
200614	14,4	-	Mavi	250	1,41
200617	14,4	-	RGB	250	3,04



## ÜÇ ÇİPLİ DİŞ MEKAN ŞERİT LEDLER



Sip. Kodu	Güç (W)	Işık Akısı (lm)	Renk Sıcaklığı (K)	Koli Adedi	Fiyat (₺)
206317	14,4	-	RGB	250	3,75
206411	10	-	6500	250	1,67



## TEK ÇİPLİ DİŞ MEKAN ŞERİT LEDLER



Sip. Kodu	Güç (W)	Renk	Koli Adedi	Fiyat (₺)
206303	4,8	Kırmızı	200	0,88
206304	4,8	Mavi	200	0,88
206803	4,8	Kırmızı	30	0,88
206808	4,8	3000K	30	0,88



## 60 LEDLİ İÇ MEKAN ŞERİT LEDLER



Sip. Kodu	Güç (W)	Işık Akısı (lm)	Renk Sıcaklığı (K)	Koli Adedi	Fiyat (₺)
202010	9,6	800	2700	250	0,72
202011	9,6	800	4000	250	0,72
202012	9,6	800	6500	250	0,72
202013	9,6	-	Kırmızı	250	0,72
202014	9,6	-	Yeşil	250	0,72
202015	9,6	-	Amber	250	0,72



## 12V NEON ŞERİT LEDLER



Sip. Kodu	Güç (W/m)	Renk	Fiyat (₺)
206701	9,6	Beyaz	3,20
206702	9,6	Gün Işığı	3,20
206703	9,6	Kırmızı	3,20
206704	9,6	Mavi	3,20
206705	9,6	Yeşil	3,20
206706	9,6	Amber	3,20
206707	9,6	Pembe	3,20

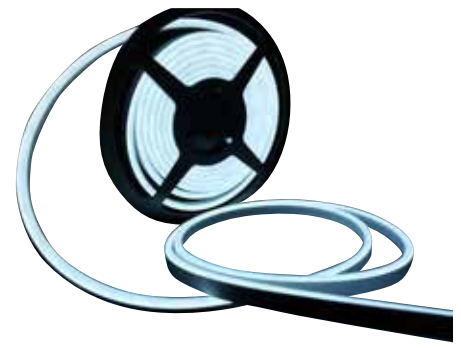

## 120 LEDLİ İÇ MEKAN ŞERİT LEDLER



Sip. Kodu	Güç (W)	Işık Akısı (lm)	Renk Sıcaklığı (K)	Koli Adedi	Fiyat (₺)
202020	9,6	800	2700	250	1,38
202021	9,6	800	4000	250	1,38
202022	9,6	800	6500	250	1,38
202023	9,6	-	Kırmızı	250	1,38
202024	9,6	-	Yeşil	250	1,38
202025	9,6	-	Amber	250	1,38



## ESNEK FLORESANLAR



Sip. Kodu	Güç (W/m)	Renk	Fiyat (₺)
206901	14,4	Beyaz	26,40
206902	14,4	Gün Işığı	26,40
206903	14,4	Kırmızı	26,40
206904	14,4	Mavi	26,40
206905	14,4	Yeşil	26,40
206906	14,4	Amber	28,00



## ARA BAĞLANTI KABLoları

Sip. Kodu	Genişlik (mm)	Boy (cm)	Kanal Sayısı	Fiyat (₺)
200001	8	15	1	0,92
200002	10	15	3 (RGB)	1,00

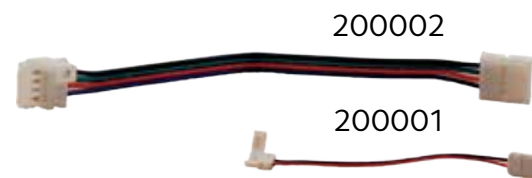

## 12 V SLİM SABİT GERİLİM GÜÇ KAYNAKLARI



Sip. Kodu	Güç (W/m)	Akım (A)	Fiyat (₺)
300155	120	10	13,08





## DIŞ MEKAN SABİT GERİLİM GÜÇ KAYNAKLARI

220 V 12 V IP 67 Aşırı Yük Koruması Kısa Devre Koruması

Sip. Kodu	Güç (W/m)	Akım (A)	Fiyat (₺)
300256	60	5	21,40



## RGB LED KONTROL ÜNİTELERİ

Sip. Kodu	Açıklama	Akım (A)	Gerilim (V)	Fiyat (₺)
300010	28 Tuşlu RF Kumanda	3 (RGB) x 6	12	10,82
300011	Güçlendirici	4 (RGBW) x 6	12	9,81



## WIFI RGBW LED KONTROL ÜNİTESİ

Sip. Kodu	Akım (A)	Gerilim (V)	Fiyat (₺)
300012	4 (RGBW) x 6	12	20,00



Google play





## OVAL INFRARED LAMBALAR

Sip. Kodu	Güç (W)	Gerilim (V)	Cam Rengi	Duy	Koli Adedi	Fiyat (\$)
41000	100	230	Kırmızı	E27	24	11,80
41011	175	230	Kırmızı	E27	24	14,00
41015	150	230	Kırmızı	E27	24	10,66
41016	150	230	Şeffaf	E27	24	9,44
41020	250	230	Kırmızı	E27	24	10,66
41021	250	230	Şeffaf	E27	24	9,44
41026	375	230	Şeffaf	E27	24	16,50



## METAL UÇLU ÇUBUK INFRARED LAMBALAR

Sip. Kodu	Güç (W)	Gerilim (V)	C	W	Ölçüler (mm)			Reflektör	Uç	Fiyat (\$)	
					E	D	D1				
40900	1000	235	365	285	470	12,3	10	14,6	Yok	X/98	25,42
40901	1000	400	365	290	470	12,3	10	14,6	Beyaz	X/98	27,10
40912	2000	400	550	426	610	12,3	10	14,6	Beyaz	X/98	27,10
40914	3000	400	769	721	902	12,3	10	14,6	Beyaz	X/98	54,20

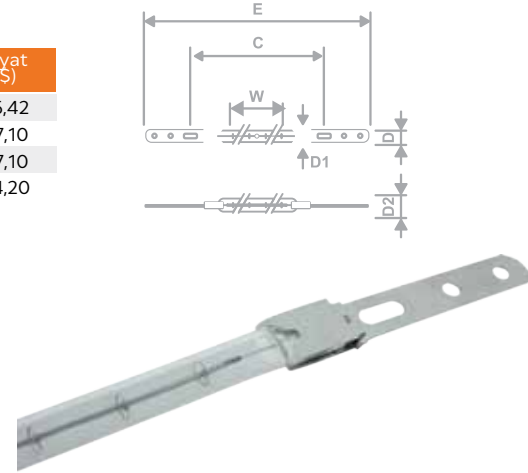

## SERAMİK UÇLU ÇUBUK INFRARED LAMBALAR

Sip. Kodu	Güç (W)	Gerilim (V)	C	W	Ölçüler (mm)			Reflektör	Duy	Uç	Fiyat (\$)
					E	D					
40902	3000	235	520	460	30	11	Beyaz	SK15	Çatal	49,28	
40906	2000	235	355	290	30	11	Beyaz	SK15	Çatal	32,04	
40909	1600	235	226	170	15	11	Beyaz	SK15	Çatal	34,50	
40910	2000	235	495	495	30	11	Beyaz	SK15	Çatal	39,42	
40913	500	235	226	159	15	11	Beyaz	SK15	Çatal	32,04	
40922	2000	235	355	296	30	11	Altın	SK15	Faston	49,04	
40941	1500	235	355	296	30	11	Altın	SK15	Faston	49,04	

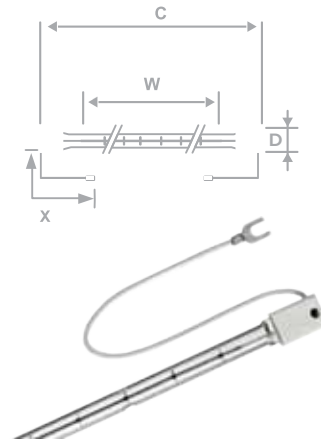

## T5 BL LAMBALAR

G5 40.000 Saat 365 nm Tepe Dalga Boyu

Sip. Kodu	Güç (W)	İrradyans (μW/cm <sup>2</sup> )	Ölçüler (b/d)	Koli Adedi	Fiyat (\$)
30900	4	3,2	150/16	20	2,10
30901	6	6	226/16	20	2,10
30902	8	9	302/16	20	2,22



## T8 BL LAMBALAR

G13 5.000 Saat 365 nm Tepe Dalga Boyu

Sip. Kodu	Güç (W)	İrradyans (μW/cm <sup>2</sup> )	Ölçüler (b/d)	Koli Adedi	Fiyat (\$)
30903	10	18	331/28	25	2,58
30904	15	23	451/28	25	3,44
30905	18	30	604/28	25	4,00
30906	20	36	604/28	25	4,93
30908	36	42	604/28	25	4,76
30909	36	58	1213/28	25	5,56



## T5 BLACKLIGHT BLUE (BLB) LAMBALAR

G5 4.000 Saat 350 - 390 nm Tepe Dalga Boyu

Sip. Kodu	Güç (W)	İrradyans (μW/cm <sup>2</sup> )	Ölçüler (b/d)	Koli Adedi	Fiyat (\$)
30950	4	2,5	150/16	20	2,32
30951	6	5	226/16	20	2,40
30952	8	8	302/16	20	2,80



## T8 BLACKLIGHT BLUE (BLB) LAMBALAR

G13 6.000 Saat 350 - 390 nm Tepe Dalga Boyu

Sip. Kodu	Güç (W)	İrradyans ( $\mu\text{W}/\text{cm}^2$ )	Ölçüler (b/d)	Koli Adedi	Fiyat (\$)
30954	15	20,6	431/28	25	6,67
30955	18	27	604/28	25	8,06
30957	30	32	604/28	25	10,16
30958	36	37,8	1213/28	25	12,49



## PLL UV-C LAMBALAR

2G11 10.000 Saat OZON ÜRETMEZ 354 nm Tepe Dalga Boyu

Sip. Kodu	Güç (W)	İrradyans ( $\mu\text{W}/\text{cm}^2$ )	Ölçüler (b/d)	Koli Adedi	Fiyat (\$)
30812	36	105	415/18	25	21,29
30813	55	142	535/17	25	23,96



## T5 UV-C LAMBALAR

G5 5.000 Saat OZON ÜRETMEZ 354 nm Tepe Dalga Boyu

Sip. Kodu	Güç (W)	İrradyans ( $\mu\text{W}/\text{cm}^2$ )	Ölçüler (b/d)	Koli Adedi	Fiyat (\$)
30806	6	11	150/16	25	5,46
30807	8	15	226/16	25	6,52
30814	11	22	212/16	25	8,25



## T5 4P UV-C LAMBALAR

G10q 10.000 Saat OZON ÜRETMEZ

Sip. Kodu	Güç (W)	İrradyans ( $\mu\text{W}/\text{cm}^2$ )	Ölçüler (b/d)	Koli Adedi	Fiyat (\$)
30820	14	40	287/16	25	25,08
30823	17	55	357/16	25	33,06
30826	21	72	436/16	25	43,32
30829	41	150	843/16	25	47,88
30832	65	189	843/16	25	60,00



## T8 UV-C LAMBALAR

G13 5.000 Saat OZON ÜRETMEZ 354 nm Tepe Dalga Boyu

Sip. Kodu	Güç (W)	İrradyans ( $\mu\text{W}/\text{cm}^2$ )	Ölçüler (b/d)	Koli Adedi	Fiyat (\$)
30808	15	48	451/28	25	7,99
30809	30	85	604/28	25	14,11
30810	36	105	1213/28	25	21,32
30811	55	135	909/28	25	18,50
30817	75	180	1199/28	25	27,37



## CAM KILIFLAR

Sip. Kodu	Ürün	Fiyat (\$)
30920	30820 İçin 320mm Kuvars Kılıf	7,00
30923	30823 İçin 390mm Kuvars Kılıf	7,50
30926	30826 İçin 470mm Kuvars Kılıf	8,00
30929	30829/30832 İçin 875mm Kuvars Kılıf	12,00



Sip. Kod	Fiyat (\$)	Sayfa No	Sip. Kod	Fiyat (\$)	Sayfa No	Sip. Kod	Fiyat (\$)	Sayfa No	Sip. Kod	Fiyat (\$)	Sayfa No	Sip. Kod	Fiyat (\$)	Sayfa No	Sip. Kod	Fiyat (\$)	Sayfa No
760310	26,90	2	770110	69,12	4	760401	43,25	8	702194	10,47	12	710476	25,53	17	500225	1,86	21
760311	26,90	2	770112	69,12	4	760501	43,25	8	710233	8,80	12	710477	17,76	17	500227	1,86	21
760312	26,90	2	770113	73,14	4	760407	43,25	8	710236	8,80	12	710478	17,76	17	500262	1,73	21
760320	33,92	2	770114	73,14	4	760507	43,25	8	710243	13,28	12	720910	25,60	17	500303	1,75	21
760321	33,92	2	770115	73,14	4	760413	47,12	8	710246	13,28	12	720911	25,60	17	500304	1,75	21
760322	33,92	2	770116	73,14	4	760513	47,12	8	710343	13,94	12	720912	25,60	17	500305	1,75	21
760330	39,28	2	770140	93,60	4	760419	49,07	8	710346	13,94	12	720920	33,00	17	500317	2,00	22
760331	39,28	2	770142	93,60	4	760519	49,07	8	711223	8,00	12	720921	33,00	17	500403	2,00	22
760332	39,28	2	770143	98,68	4	760426	49,04	8	711226	8,00	12	720922	33,00	17	500405	2,00	22
760340	63,00	2	770144	98,68	4	760526	49,04	8	711243	11,40	12	720930	33,00	17	500404	1,75	22
760341	63,00	2	770145	98,68	4	760431	42,80	8	711246	11,40	12	720931	33,00	17	500407	1,75	22
760342	63,00	2	770146	98,68	4	760531	42,80	8	712243	11,97	12	720932	33,00	17	500408	1,75	22
760250	25,62	2	770170	131,04	4	730134	5,00	8	712246	11,97	12	721110	28,20	17	500312	2,78	22
760251	25,62	2	770172	131,04	4	730135	5,00	8	710033	3,13	13	721111	28,20	17	500355	2,78	22
760252	25,62	2	770173	144,22	4	730100	8,06	9	710034	3,13	13	721112	28,20	17	500357	2,78	22
760260	32,30	2	770174	144,22	4	730101	16,12	9	710036	3,13	13	721120	36,00	17	500362	3,80	23
760261	32,30	2	770175	144,22	4	730102	24,19	9	710063	3,50	13	721121	36,00	17	500370	7,20	23
760262	32,30	2	770176	144,22	4	730103	8,06	9	710064	3,50	13	721122	36,00	17	500372	7,20	23
760270	37,40	2	770230	195,84	5	730104	16,12	9	710066	3,50	13	721130	36,00	17	500376	8,90	23
760271	37,40	2	770232	195,84	5	730105	24,19	9	710093	4,34	13	721131	36,00	17	500379	8,90	23
760272	37,40	2	770233	216,66	5	730108	1,69	9	710094	4,34	13	721132	36,00	17	500342	2,80	24
760540	60,00	2	770234	216,66	5	730109	1,69	9	710096	4,34	13	720150	5,88	18	500267	8,60	24
760541	60,00	2	770235	216,66	5	730114	3,05	9	710123	4,78	13	720151	5,88	18	500269	8,60	24
760542	60,00	2	770236	216,66	5	730115	3,05	9	710124	4,78	13	720152	6,20	18	500268	9,45	24
760360	33,92	2	780110	79,20	5	730106	9,50	9	710126	4,78	13	720154	6,30	18	500270	9,45	24
760361	33,92	2	780112	79,20	5	730107	9,50	9	710153	5,73	13	720155	6,30	18	500830	4,90	25
760362	33,92	2	780113	84,18	5	730112	1,25	9	710154	5,73	13	720156	6,72	18	500831	4,90	25
710458	16,00	2	780114	84,18	5	730113	1,25	9	710156	5,73	13	720158	12,60	18	500832	4,90	25
750822	57,20	3	780115	84,18	5	730110	3,20	9	710183	6,10	13	720159	12,60	18	500833	6,45	25
750832	70,60	3	780116	84,18	5	730111	3,20	9	710184	6,10	13	720160	13,44	18	500834	6,45	25
750842	84,00	3	780140	108,00	5	760253	8,00	10	710186	6,10	13	720162	2,35	18	500835	6,45	25
750622	66,70	3	780142	108,00	5	760256	8,00	10	710200	12,70	13	720163	2,35	18	500820	9,00	25
750632	100,00	3	780143	113,16	5	760483	24,00	10	710201	12,70	13	720164	2,63	18	500523	4,51	25
750642	120,00	3	780144	113,16	5	760484	24,00	10	710202	12,70	13	720166	2,44	18	500513	5,40	25
750722	98,60	3	780145	113,16	5	760486	24,00	10	710411	6,50	13	720167	2,44	18	500552	8,00	25
750732	134,00	3	780146	113,16	5	760489	21,00	10	710412	6,50	13	720168	2,73	18	500555	5,81	25
750742	152,00	3	702103	14,00	6	760490	21,00	10	710413	6,50	13	500114	1,45	20	500565	3,15	26
750400	11,00	3	702203	14,00	6	760491	21,00	10	710414	9,70	13	500115	1,45	20	500584	3,23	26
750402	11,00	3	702101	13,74	6	760497	27,22	10	710415	9,70	13	500121	1,95	20	500587	3,92	26
750403	11,55	3	702201	13,74	6	760498	27,22	10	710416	9,70	13	500130	2,64	20	500610	2,20	26
750404	11,55	3	702301	15,68	6	760499	27,22	10	750900	51,63	14	500132	2,64	20	500612	2,70	26
750405	26,00	3	702123	14,94	6	760493	Fiyat Sorunuz	10	750902	59,00	14	500170	3,90	20	500620	2,85	26
750410	18,44	3	702223	14,94	6	760494	Fiyat Sorunuz	10	750904	70,00	14	500171	3,90	20	500621	3,00	26
750412	18,44	3	701107	19,94	6	760495	Fiyat Sorunuz	10	750901	52,40	14	500172	3,90	20	500625	2,95	27
750413	20,00	3	701207	19,94	6	760471	31,00	10	750903	61,16	14	500173	5,12	20	500652	4,48	27
750414	20,00	3	701307	21,20	6	760472	31,00	10	750905	72,84	14	500174	5,12	20	500670	4,35	27
750430	24,80	3	702104	19,94	6	760473	31,00	10	703201	18,87	15	500175	5,12	20	500673	3,80	27
750432	24,80	3	702204	19,94	6	760479	37,00	10	703202	18,87	15	500176	7,22	20	500674	3,80	27
750435	27,28	3	702102	18,85	6	760480	37,00	10	703203	18,87	15	500177	7,22	20	500672	6,34	27
750450	38,50	3	702202	18,85	6	760481	37,00	10	703204	18,87	15	500178	7,22	20	800100	0,54	29
750452	38,50	3	702302	22,00	6	760475	Fiyat Sorunuz	10	703101	25,75	15	500179	9,60	20	800101	0,54	29
750460	75,00	3	701106	22,49	7	760476	Fiyat Sorunuz	10	703102	25,75	15	500180	9,60	20	800102	0,54	29
750462	75,00	3	702206	22,49	7	760477	Fiyat Sorunuz	10	703103	28,42	15	500181	9,60	20	800103	0,54	29
750470	98,20	3	702306	25,11	7	710700	4,80	11	710470	14,82	16	500182	12,45	20	800104	0,54	29
750472	98,20	3	702124	19,94	7	710760	11,00	11	710471	14,82	16	500183	12,45	20	800105	0,54	29
750490	187,00	3	702224	19,94	7	710775	19,80	11	710472	15,41	16	500184	12,45	20	800106	0,54	29
750492	187,00	3	702108	22,49	7	710710	4,80	11	710473	15,41	16	500713	1,78	20	800107	0,60	29
750591	280,00	3	702208	22,49	7	710770	15,32	11	710474	24,84	16	500715	1,78	20	800110	2,94	29
750592	280,00	3	702308	25,11	7	710765	0,67	11	710475	24,84	16	500216	1,95	20	800200	2,36	29
750442	28,48	3	701101	15,23	7	702186	15,82	11				500218	1,95	20	800210	6,20	29
			701201	15,23	7	712186	20,34	11							800300	1,80	29
			701302	21,00	7	702196	17,10	11							800301	1,80	29
			701301	21,00	7	702191	12,80	11									

Sip. Kod	Fiyat (\$)	Sayfa No	Sip. Kod	Fiyat (\$)	Sayfa No
201101	0,80	32	41000	11,80	38
201103	0,80	32	41011	14,00	38
201105	0,80	32	41015	10,66	38
201106	1,02	32	41016	9,44	38
200621	1,00	32	41020	10,66	38
200629	1,00	32	41021	9,44	38
200622	1,00	32	41026	16,50	38
200624	1,00	32	40900	25,42	38
200626	1,00	32	40901	27,10	38
200614	1,41	32	40912	27,10	38
200617	3,04	32	40914	54,20	38
101102	1,77	33	40902	49,28	38
99558	2,57	33	40906	32,04	38
99559	2,57	33	40909	34,50	38
99561	2,57	33	40910	39,42	38
206317	3,75	33	40913	32,04	38
206411	1,67	33	40922	49,04	38
206303	0,88	33	40941	49,04	38
206304	0,88	33	30900	2,10	39
206803	0,88	33	30901	2,10	39
206808	0,88	33	30902	2,22	39
202010	0,72	34	30903	2,58	39
202011	0,72	34	30904	3,44	39
202012	0,72	34	30905	4,00	39
202013	0,72	34	30906	4,93	39
202014	0,72	34	30908	4,76	39
202015	0,72	34	30909	5,56	39
202020	1,38	34	30950	2,32	39
202021	1,38	34	30951	2,40	39
202022	1,38	34	30952	2,80	39
202023	1,38	34	30954	6,67	40
202024	1,38	34	30955	8,06	40
202025	1,38	34	30957	10,16	40
200001	0,92	34	30958	12,49	40
200002	1,00	34	30806	5,46	40
206701	3,20	35	30807	6,52	40
206702	3,20	35	30814	8,25	40
206703	3,20	35	30808	7,99	40
206704	3,20	35	30809	14,11	40
206705	3,20	35	30810	21,32	40
206706	3,20	35	30811	18,50	40
206707	3,20	35	30817	27,37	40
206901	26,40	35	30812	21,29	41
206902	26,40	35	30813	23,96	41
206903	26,40	35	30820	25,08	41
206904	26,40	35	30823	33,06	41
206905	26,40	35	30826	43,32	41
206906	28,00	35	30829	47,88	41
300155	13,08	35	30832	60,00	41
300256	21,40	36	30920	7,00	41
300010	10,82	36	30923	7,50	41
300011	9,81	36	30926	8,00	41
300012	20,00	36	30929	12,00	41



# SAVK

*Karanlıktan Savk'a*

## 2025 FIYAT LİSTESİ

[www.savk.com.tr](http://www.savk.com.tr)  
[www.baldem.com.tr](http://www.baldem.com.tr)

